



Network Video Recorder

Installation Manual

DR-6308P-S / DR-6308P-SA

DR-6316PS-S / DR-6316PS-SA

DR-6332PS-S / DR-6332PS-SA



Powered by **Direct IP™**

Before reading this manual

This manual contains basic instructions on installing and using DirectIP™ Network Video Recorder, an IDIS product. Users who are using this product for the first time, as well as users with experience using comparable products, must read this manual carefully before use and heed to the warnings and precautions contained herein while using the product. Safety warnings and precautions contained in this manual are intended to promote proper use of the product and thereby prevent accidents and property damage and must be followed at all times. Once you have read this manual, keep it at an easily accessible location for future reference.

- The manufacturer will not be held responsible for any product damage resulting from the use of unauthorized parts and accessories or from the user's failure to comply with the instructions contained in this manual.
- It is recommended that first-time users of DirectIP™ Network Video Recorder and individuals who are not familiar with its use seek technical assistance from their retailer regarding product installation and use.
- If you need to disassemble the product for functionality expansion or repair purposes, you must contact your retailer and seek professional assistance.
- Both retailers and users should be aware that this product has been certified as being electromagnetically compatible for commercial use. If you have sold or purchased this product unintentionally, please replace with a consumer version.

Safety Precautions

	CAUTION	
RISK OF ELECTRIC SHOCK DO NOT OPEN		
CAUTION: TO REDUCE THE RISK OF ELECTRIC SHOCK, DO NOT REMOVE COVER (OR BACK). NO USER-SERVICEABLE PARTS INSIDE. REFER SERVICING TO QUALIFIED SERVICE PERSONNEL.		



The lightning flash with arrowhead symbol, within an equilateral triangle, is intended to alert the user to the presence of uninsulated "dangerous voltage" within the product's enclosure that may be of sufficient magnitude to constitute a risk of electric shock.



The exclamation point within an equilateral triangle is intended to alert the user to the presence of important operating and maintenance (servicing) instructions in the literature accompanying the appliance.

Symbol	Publication	Description
	IEC60417, No.5032	Alternating current

WARNING
Hazardous moving parts
Keep away from moving fan blades

AVERTISSEMENT
Pièces mobiles dangereuses
Se tenir éloigné des pales de ventilateurs mobiles

1. Read Instructions

All the safety and operating instructions should be read before the appliance is operated.

2. Retain Instructions

The safety and operating instructions should be retained for future reference.

3. Cleaning

Unplug this equipment from the wall outlet before cleaning it. Do not use liquid aerosol cleaners. Use a damp soft cloth for cleaning.

4. Attachments

Never add any attachments and/or equipment without the approval of the manufacturer as such additions may result in the risk of fire, electric shock or other personal injury.

5. Water and/or Moisture

Do not use this equipment near water or in contact with water.

6. Ventilation

Place this equipment only in an upright position. This equipment has an open-frame Switching Mode Power Supply (SMPS), which can cause a fire or electric shock if anything is inserted through the ventilation holes on the side of the equipment.

7. Accessories

Do not place this equipment on an unstable cart, stand or table. The equipment may fall, causing serious injury to a child or adult, and serious damage to the equipment. Wall or shelf mounting should follow the manufacturer's instructions, and should use a mounting kit approved by the manufacturer.



This equipment and cart combination should be moved with care. Quick stops, excessive force, and uneven surfaces may cause the equipment and cart combination to overturn.

8. Power Sources

This equipment should be operated only from the type of power source indicated on the marking label. If you are not sure of the type of power, please consult your equipment dealer or local power company.

You may want to install a UPS (Uninterruptible Power Supply) system for safe operation in order to prevent damage caused by an unexpected power stoppage. Any questions concerning UPS, consult your UPS retailer. This equipment should be remain readily operable.

9. Power Cords

Operator or installer must remove power and TNT connections before handling the equipment.

10. Lightning

For added protection for this equipment during a lightning storm, or when it is left unattended and unused for long periods of time, unplug it from the wall outlet and disconnect the antenna or cable system. This will prevent damage to the equipment due to lightning and power-line surges.

11. Overloading

Do not overload wall outlets and extension cords as this can result in the risk of fire or electric shock.

12. Objects and Liquids

Never push objects of any kind through openings of this equipment as they may touch dangerous voltage points or short out parts that could result in a fire or electric shock. Never spill liquid of any kind on the equipment.

13. Servicing

Do not attempt to service this equipment yourself. Refer all servicing to qualified service personnel.

14. Damage requiring Service

Unplug this equipment from the wall outlet and refer servicing to qualified service personnel under the following conditions:

- A. When the power-supply cord or the plug has been damaged.
- B. If liquid is spilled, or objects have fallen into the equipment.
- C. If the equipment has been exposed to rain or water.
- D. If the equipment does not operate normally by following the operating instructions, adjust only those controls that are covered by the operating instructions as an improper adjustment of other controls may result in damage and will often require extensive work by a qualified technician to restore the equipment to its normal operation.
- E. If the equipment has been dropped, or the cabinet damaged.
- F. When the equipment exhibits a distinct change in performance this indicates a need for service.

15. Replacement Parts

When replacement parts are required, be sure the service technician has used replacement parts specified by the manufacturer or that have the same characteristics as the original part. Unauthorized substitutions may result in fire, electric shock or other hazards.

16. Safety Check

Upon completion of any service or repairs to this equipment, ask the service technician to perform safety checks to determine that the equipment is in proper operating condition.

17. Field Installation

This installation should be made by a qualified service person and should conform to all local codes.

18. Correct Batteries

Warning: Risk of explosion if battery is replaced by an incorrect type. Replace only with the same or equivalent type. Dispose of used batteries according to the instructions. The battery shall not be exposed to excessive heat such as sunshine, fire or the like.

Avertissement: risque d'explosion en cas d'utilisation d'une batterie de type incorrect. Le remplacer uniquement par un type identique ou équivalent. Mettre les batteries usées au rebut conformément aux instructions. La batterie ne doit pas être exposée à une source de chaleur excessive, telle que le soleil, le feu, ou analogue.

19. Tmra

A manufacturer's maximum recommended ambient temperature (Tmra) for the equipment must be specified so that the customer and installer may determine a suitable maximum operating environment for the equipment.

20. Elevated Operating Ambient Temperature

If installed in a closed or multi-unit rack assembly, the operating ambient temperature of the rack environment may be greater than room ambient. Therefore, consideration should be given to installing the equipment in an environment compatible with the manufacturer's maximum rated ambient temperature (Tmra).

21. Reduced Air Flow

Installation of the equipment in the rack should be such that the amount of airflow required for safe operation of the equipment is not compromised.

22. Mechanical Loading

Mounting of the equipment in the rack should be such that a hazardous condition is not caused by uneven mechanical loading.

23. Circuit Overloading



Consideration should be given to connection of the equipment to supply circuit and the effect that overloading of circuits might have on over current protection and supply wiring. Appropriate consideration of equipment nameplate ratings should be used when addressing this concern.

24. Reliable Earthing (Grounding)

Reliable grounding of rack mounted equipment should be maintained. Particular attention should be given to supply connections other than direct connections to the branch circuit (e.g., use of power strips).

Important Safeguards

In-Text

Symbol	Type	Description
	Caution	Important information concerning a specific function.
	Note	Useful information concerning a specific function.

User's Caution Statement

Caution: Any changes or modifications to the equipment not expressly approved by the party responsible for compliance could void your authority to operate the equipment.

FCC Compliance Statement

THIS EQUIPMENT HAS BEEN TESTED AND FOUND TO COMPLY WITH THE LIMITS FOR A CLASS A DIGITAL DEVICE, PURSUANT TO PART 15 OF THE FCC RULES. THESE LIMITS ARE DESIGNED TO PROVIDE REASONABLE PROTECTION AGAINST HARMFUL INTERFERENCE WHEN THE EQUIPMENT IS OPERATED IN A COMMERCIAL ENVIRONMENT. THIS EQUIPMENT GENERATES, USES, AND CAN RADIATE RADIO FREQUENCY ENERGY AND IF NOT INSTALLED AND USED IN ACCORDANCE WITH THE INSTRUCTION MANUAL, MAY CAUSE HARMFUL INTERFERENCE TO RADIO COMMUNICATIONS. OPERATION OF THIS EQUIPMENT IN A RESIDENTIAL AREA IS LIKELY TO CAUSE HARMFUL INTERFERENCE, IN WHICH CASE USERS WILL BE REQUIRED TO CORRECT THE INTERFERENCE AT THEIR OWN EXPENSE.

WARNING: CHANGES OR MODIFICATIONS NOT EXPRESSLY APPROVED BY THE PARTY RESPONSIBLE FOR COMPLIANCE COULD VOID THE USER'S AUTHORITY TO OPERATE THE EQUIPMENT.

THIS CLASS OF DIGITAL APPARATUS MEETS ALL REQUIREMENTS OF THE CANADIAN INTERFERENCE CAUSING EQUIPMENT REGULATIONS.

WEEE (Waste Electrical & Electronic Equipment)

Correct Disposal of This Product

(Applicable in the European Union and other European countries with separate collection systems)



This marking shown on the product or its literature, indicates that it should not be disposed with other household wastes at the end of its working life. To prevent possible harm to the environment or human health from uncontrolled waste disposal, please separate this from other types of wastes and recycle it responsibly to promote the sustainable reuse of material resources.

Household users should contact either the retailer where they purchased this product, or their local government office, for details of where and how they can take this item for environmentally safe recycling.

Business users should contact their supplier and check the terms and conditions of the purchase contract. This product should not be mixed with other commercial wastes for disposal.

Copyright

© 2020 IDIS Co., Ltd.

IDIS Co., Ltd. reserves all rights concerning this manual.

Use or duplication of this manual in part or whole without the prior consent of IDIS Co., Ltd. is strictly prohibited.

Contents of this manual are subject to change without prior notice.

Registered Trademarks

IDIS is a registered trademark of IDIS Co., Ltd.

Other company and product names are registered trademarks of their respective owners.

The information in this manual is believed to be accurate as of the date of publication even though explanations of some functions may not be included. We are not responsible for any problems resulting from the use thereof. The information contained herein is subject to change without notice. Revisions or new editions to this publication may be issued to incorporate such changes.

The software included in this product contains some Open Sources. You may obtain the complete corresponding source code depending on whether or not the source is publicly available under a license policy. Go to System Setup - About page for more information. This product includes software developed by the University of California, Berkeley and its contributors, and software developed by the OpenSSL Project for use in the OpenSSL Toolkit (<http://www.openssl.org/>). Also, this product includes cryptographic software written by Eric Young (eay@cryptsoft.com), and software written by Tim Hudson (tjh@cryptsoft.com).

Table of Contents

1

Part 1 – Introduction..... 7

- Product Features7
- Accessories.....9
- Overview10
 - Front Panel.....10
 - Dimensions.....12
 - Rear Panel13
 - Rear Panel Connections13
 - Remote Control18

2

Part 2 - Appendix.....21

- System Log Types21
- Error Code Types22
- Troubleshooting25
- Specifications26

Part 1 – Introduction

Product Features

This is a DirectIP™-enabled video recorder that supports surveillance, recording, and playback of video from network cameras (or video encoders).

This NVR (Network Video Recorder) unit offers the following features:

- Real-time 8/16/32-channel DirectIP™ network surveillance
- Network camera zero configuration
- Configuration-free network camera access
- UHD resolution support
- H.265 support
- Supports up to Full HD 960ips video recordingn (DR-6332PS-S)
- HDMI out (1) and VGA out (1) ports
- Fast and easy search feature (Time-Lapse, Event log, Motion, Text-In)
- Simultaneously survey, record, play back, and transmit data in real-time
- Graphic User Interface(GUI) and multilingual
- Multiple recording modes (Schedule, Event, Pre-Event, and Panic)
- PoE-enabled Camera Connection
- 1 USB 2.0 port, 1 USB 3.0 port (for connecting peripherals, upgrading software, and saving recording data)
- 6 internal SATA2 HDD bays and 4 eSATA ports
- Records the same data on the two disks at the same time (RAID 1)
- Two-way audio communication
- Network camera audio recording and 1-channel audio playback
- 4 alarm ins, 1 alarm out, and 1 alarm reset
- IR remote control-enabled
- Self-diagnosis and automated system event alerts (industry standard S.M.A.R.T. protocol for HDD status alerts)
- Exports setup, system log and clip-copy files on network

Part 1 – Introduction





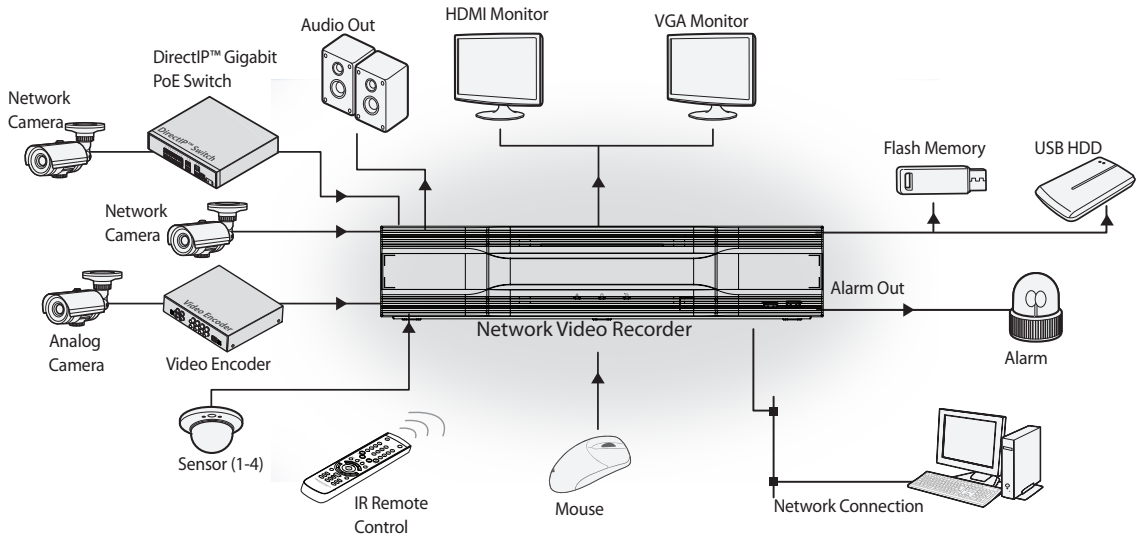

This document covers the 8-, 16-, and 32-channel network video recorders. The NVRs are identical except for the number of cameras and alarms that can be connected and the number of cameras that can be displayed. For simplicity, the illustrations and descriptions in this document refer to the 32-channel model.

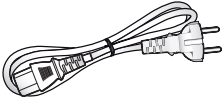
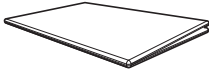

Accessories

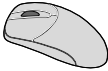
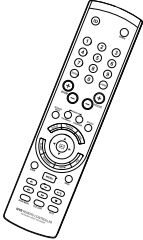
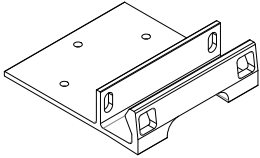
Upon unpackaging the product, check the contents inside to ensure that all the following accessories are included.

		
Network Video Recorder	Power Cable	Quick Guide
		
SATA2 cables	Optical USB Mouse	IR Remote Control
		
Rack-mount Kit	Assembly Screws for Adding Hard Disk Drives	

Overview

Front Panel

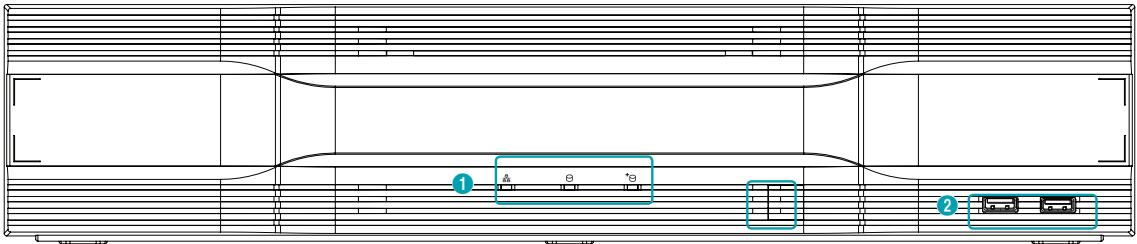

①	LEDs	②	USB Ports
---	------	---	-----------

- ✓ Remote control sensor is located on the right side of the front panel. Ensure that the sensor remains unobstructed at all times. If obstructed, the sensor might not be able to receive remote control signals.
- Placing a Wi-Fi, Bluetooth, or any other wireless communication device near the NVR may interfere with remote control signal transmission.
- Access various windows and menus using a USB mouse as you would on a personal computer.
- For easier system configuration, a USB mouse is recommended.

① LEDs

- **Network LED:** Flashes when the main unit is linked to an ethernet.
- **HDD LED:** Flashes when data is being written on the HDD or a video search is in progress.
- **eSATA LED:** Lights up when the main unit is connected to an eSATA device.

② USB Ports

• Storage Device Connection

Connect an external USB hard drive or a USB flash memory device to one of the USB ports for use with the Clip Copy feature. The external storage device should be placed as close to the NVR as possible. It is recommended that you use a connection cable that is no longer than 180cm in length. Use the connection cable included with your external storage device to connect the device to one of NVR's USB ports. For more information Clip Copy, refer to the **Clip Copy in the operation manual**.

• Peripheral Device Connection

Use the USB ports to connect peripherals such as a USB mouse to the NVR. You can also use a USB-to-serial converter and connect multiple text-in devices to the NVR at the same time.

- ✓ For USB flash memory devices, the NVR supports the FAT32 file format only.

Connections on the Front Panel

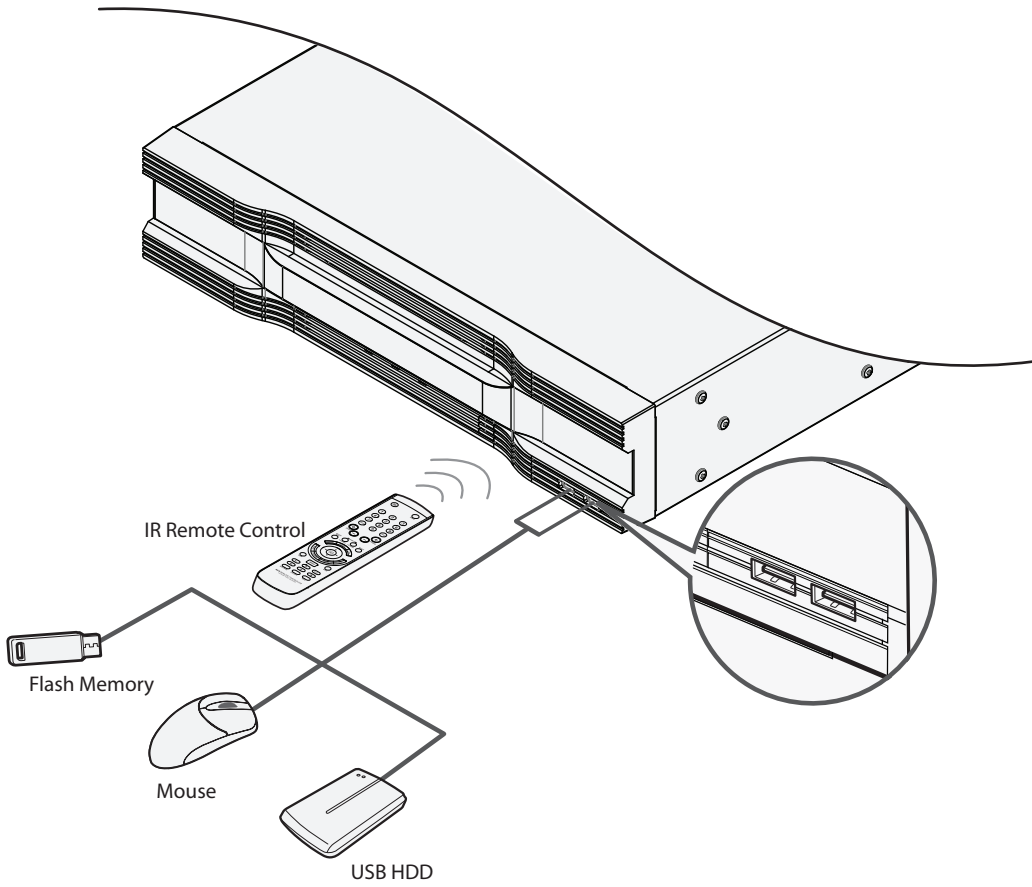

Dimensions

(Unit : mm)

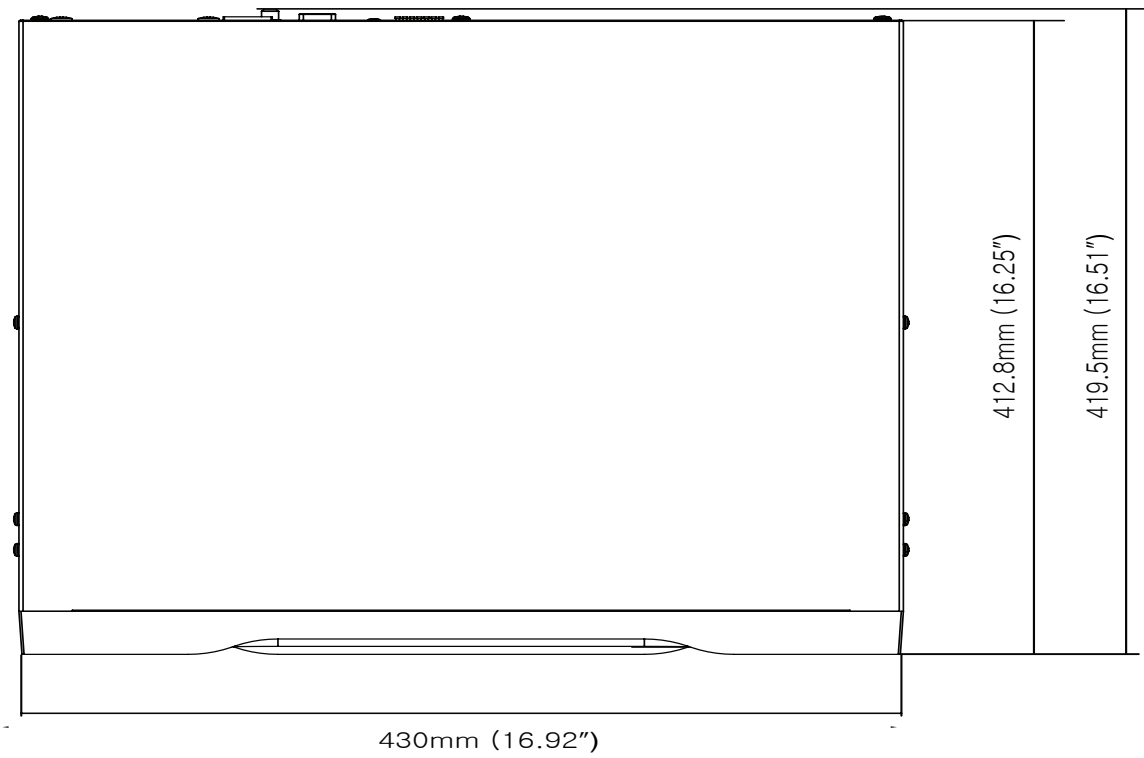
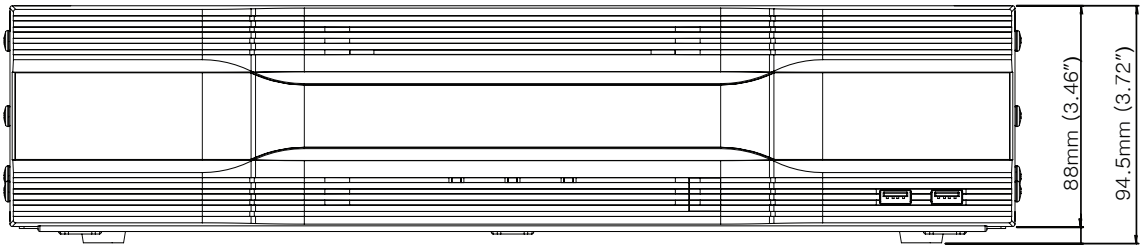

Rear Panel

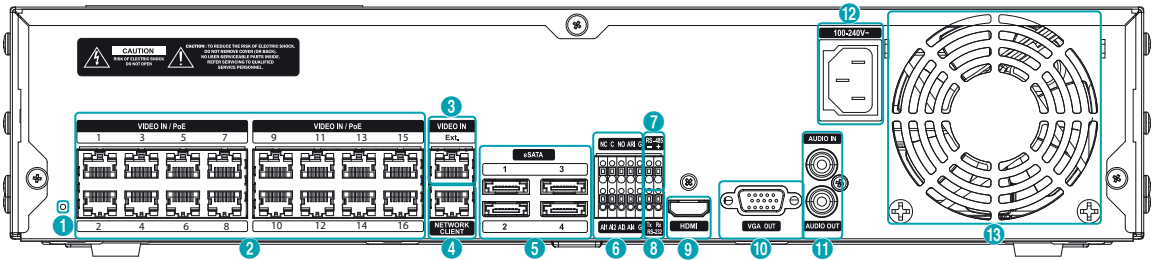

1	Factory Reset Button	2	Video In / PoE Ports	3	Video In / Ext. Port
4	Network Port	5	eSATA Ports	6	Alarm Connection Ports
7	RS-485 Port	8	RS-232 Port	9	HDMI Out Port
10	VGA Out Port	11	Audio Ports	12	Power In Port
13	Vent				

Rear Panel Connections

Monitor Connection

Connect to the **VGA OUT** or **HDMI** port.

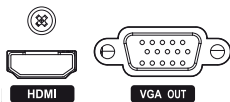

- This NVR does not feature a built-in audio amplifier unit and therefore requires the user to purchase a speaker system with a built-in amplifier separately. It's possible to connect an amplified audio source to the NVR, but microphones that do not have a built-in amplifier will not function properly if connected to the NVR directly. If this is the case, connect the microphone to the NVR via a pre-amp.
- Check your local laws and regulations on making audio recordings.

Audio Connection



Connect the audio device to the **AUDIO IN** port and speakers with a built-in amplifier to the **AUDIO OUT** port. Use the **AUDIO OUT** port to listen to audio from network cameras.

Use the **AUDIO IN** port to establish two-way communication with cameras.

Video Connection

• Video In/PoE Port

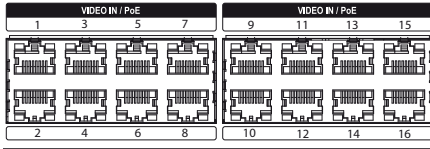

Connect network cameras or video encoders to the NVR using RJ-45 cable (Cat5e, or Cat6). In addition to cameras or video encoders, you can connect external hubs (Optional: DH-2112PF, DH-2128PF) to form a network. The NVR recognizes DirectIP™ network cameras automatically. Ports 1 through 16 support PoE.

- ✓ We recommend that you use the Ext. port for connecting to an external hub and using features such as camera alignment.
- Green LED on the right will turn on when PoE comes on line. Orange LED on the left will then flash once a link has been established.
- If more than 16 cameras from video encoders are registered on the NVR, video may not be displayed smoothly in a remote program.

• Video In / Ext. Port



This port does not support PoE. It's possible to establish a network with network cameras and external hubs using a Cat6 cable.

- ✓ Green LED on the right will turn on if connected to a 1000 BASE-T network. Orange LED on the left will then flash once a link has been established.
- When using a Cat5e cable, the data transfer speed may decrease depending on how to establish a network.

Network Connection



This NVR is capable of connecting to networks via an ethernet connector. Connect an RJ-45 cable (Cat5e, or Cat6) to the NVR's network port. It's possible to operate and upgrade the NVR remotely over a network. For more information on ethernet connection setup, refer to **Network Setup in the operation manual.**

- ✓ Connector directions may vary depending on the NVR model.
- Green LED on the right will begin to flash if connected a 1000 BASE-T network. Orange LED on the left will then flash once a link has been established.

eSATA Connection

Connect external hard drives to these ports.

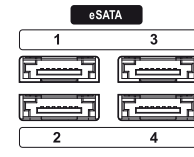

- ⚠ Do not connect or disconnect an eSATA device while the NVR is powered on. To connect an eSATA device, first turn off the NVR and unplug the power cable. Connect the eSATA device and then power the eSATA device first and then NVR back on. To disconnect an eSATA device, first turn off the NVR and unplug the power cable. Turn off the eSATA device and then disconnect the eSATA connection cable.

RS-232 Connection

Connect an external device such as a POS unit to this port.



RS-485 Connection

This NVR supports the RS-485 half-duplex serial communication protocol for connecting to external devices such as POS units.



Alarm Connection

Connect alarm connectors to these ports.

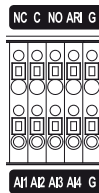

Press down on the button and insert the cable into the opening. Release the button and then pull on the cable slightly to ensure it is held securely in place. To disconnect the cable, press down on the button again and pull the cable out.

- **Alarm In 1 through 4**

This NVR is capable of responding to event signals from external alarm in devices. Connect mechanical or electrical switches to AI 1 through 4 and the G (ground) connector. In order to be recognized by the NVR, the signal from an alarm in device must be less than 0.3V (Normally Open) and maintained for at least 0.5 seconds. The alarm in voltage range is 0V to 5V. For more information on alarm in setup, refer to the [Alarm-In in the operation manual](#).

- **G (Ground)**

Connect alarm in or out's ground cable to the G connector.

All connectors marked "G" are common connectors.

- **NC/NO (Relay Alarm Outputs)**

This NVR is capable of activating/deactivating buzzers, lights, and other external devices. Connect the device to the C (Common) and NC (Normally Closed) or C and NO (Normally Open) connectors. NC/NO is a relay output which sinks 2A@125VAC and 1A@30VDC. For more information on alarm out setup, refer to the [Alarm-Out in the operation manual](#).

- **ARI (Alarm Reset In)**

An external signal to the Alarm Reset In can be used to reset both the Alarm Out signal and the NVR's internal buzzer. Mechanical or electrical switches can be wired to the ARI (Alarm Reset In) and GND (Ground) connectors. The threshold voltage is below 0.3V and should be stable at least 0.5 seconds to be detected. Connect the wires to the ARI and GND connectors.

- **Connector Arrangement**

AI1 through AI4	Alarm In 1 through 4
G	Ground
C	Relay Common
NO/NC	Normally Open and Normally Close Relay Alarm Out (connected to C port)

Power Cable Connection

Connect the power cable to this port. This NVR does not feature a separate power on/off button and will turn on the moment power is supplied.

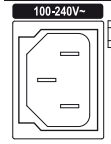

- Organize the power cable so that it will not cause people to trip over or become damaged from chairs, cabinets, desks, and other objects in the vicinity. Do not run the power cable underneath a rug or carpet.
- The power cable is grounded. Do not modify the power plug even if your power outlet does not have a ground contact.
- Do not connect multiple devices to a single power outlet.

Factory Reset

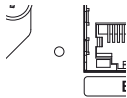

Located left next to the Video In / PoE port on the rear of the NVR is a switch that, once activated, will reset the NVR to all its initial factory settings.



A factory reset will clear all NVR settings configured by the user.



You will need a straightened paper clip to access the factory reset button.

- 1 Turn off the NVR.
- 2 Insert a straightened paper clip into the factory reset switch hole and press the switch. Turn on the NVR while holding the switch.
- 3 Press and hold until you hear 2 beeps from the NVR's internal buzzer.
- 4 All NVR settings will be returned to their factory values once you remove the paper clip.

Connections on the Rear Panel

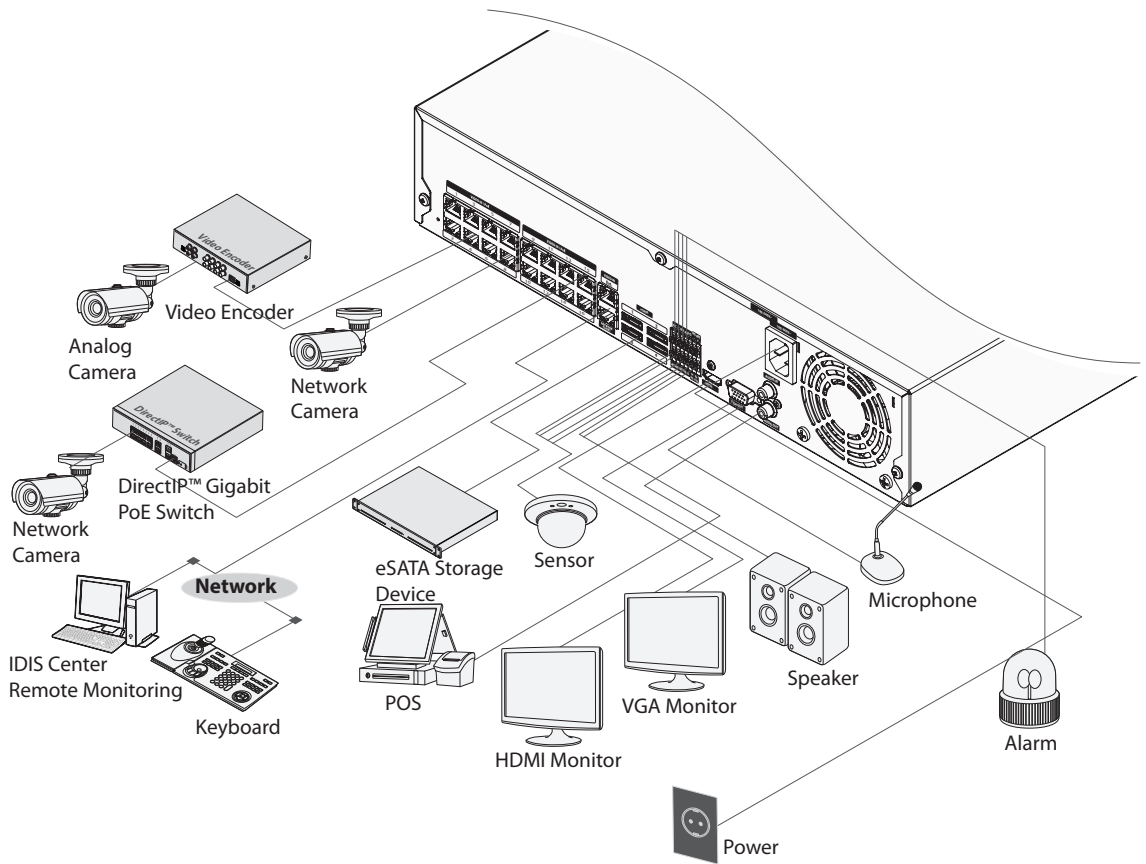

Remote Control

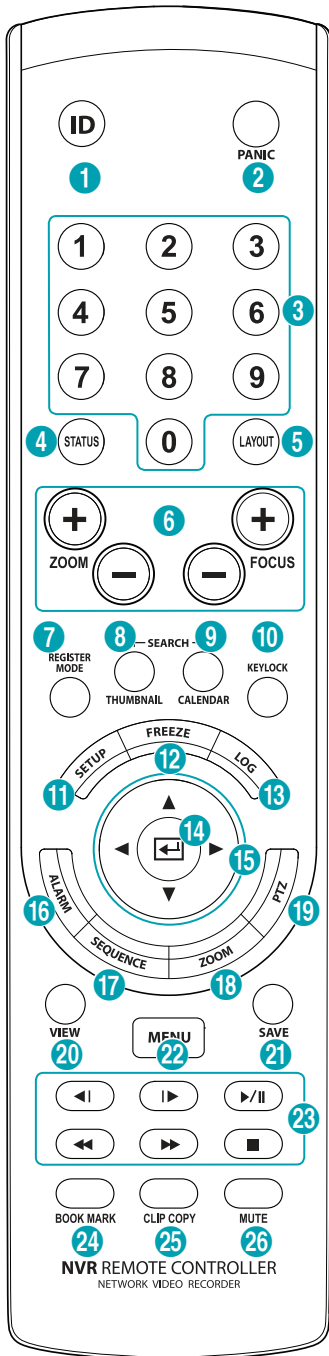

1	ID Button
2	PANIC Button
3	Camera Buttons
4	STATUS Button
5	LAYOUT Button
6	PTZ Control Buttons
7	REGISTER MODE Button
8	THUMBNAIL Button
9	CALENDAR Button
10	KEYLOCK Button
11	SETUP Button
12	FREEZE Button
13	LOG Button
14	Enter Button
15	Arrow Buttons
16	ALARM Button
17	SEQUENCE Button
18	ZOOM Button
19	PTZ Button
20	VIEW Button
21	SAVE Button
22	MENU Button
23	Playback Buttons
24	BOOKMARK Button
25	CLIP COPY Button
26	MUTE Button

① **ID** Button

Used to assign remote control ID values. No additional remote control assignment is necessary if the system's ID is 0. If the system's ID is a number between 1 and 99, however, you will need to press the ID button and then press the system ID number on the remote control. If the system's ID is set in double digits, press each digit button consecutively. The  (remote control) icon will appear on the upper right corner of the NVR screen (status indication area) to indicate successful system-to-remote control pairing. If using multiple systems, it's possible to control all the units with a single remote control as long as all the system IDs are 0. For more information on system IDs, refer to the **System Setup in the operation manual**.

② **PANIC** Button

Pressing this button displays the  icon and commences recording irrespective of the current schedule. Press the button again to deactivate Panic Recording mode.

③ **Camera** Buttons

Pressing the **Camera** button while in Live or Playback mode displays images from the selected camera in full screen. To select a camera whose channel is made up of two digits, enter the digits in sequence using the number keys.

④ **STATUS** Button

Displays event, recording device and network statuses.

⑤ **LAYOUT** Button

1x1 > 2x2 > 1+5 > 1+7 > 3x3 > 4x4 > 5x5 > 6x6

⑥ **PTZ** Control Buttons

Used in PTZ mode to zoom in/out on the screen and to shift focus between a nearby point and a far away point.

⑦ **REGISTER MODE** Button

Used in Live mode to access Camera Registration mode.

⑧ **THUMBNAIL** Button

Used in Playback mode to access Thumbnail Search mode. Thumbnail Search mode displays thumbnails of video recordings and allows you to search recordings based on date, time, minutes, seconds and parameters (Will be supported).

⑨ **CALENDAR** Button

Displays a video recording playback screen that includes a calendar.

⑩ **KEYLOCK** Button

Locks out all remote control keys. To unlock, press the button again.

⑪ **SETUP** Button

Pressing the **SETUP** button while in Live mode displays the setup menu.

⑫ **FREEZE** Button

Used to pause Live screen.

⑬ **LOG** Button

Displays system log window and allows you to search the log.

14 Enter Button
Used to make menu option selections and register data entries. In addition, pressing this button while a camera screen is selected by pressing the **Menu** button in Live or Playback mode displays the Camera menu.

15 Arrow Buttons
Used to navigate through menus and interact with GUIs. In a Setup menu, use the **Up/Down Arrow** buttons to increase or decrease numerical values. In Live or Playback mode, use the **Left/Right Arrow** buttons to view the previous or next screen.

16 ALARM Button
Pressing this button while the alarm has been activated resets all NVR outputs, including the built-in buzzer. Displays the event log on the screen when the alarm is off in Live mode.

17 SEQUENCE Button
Pressing the **SEQUENCE** button while in Live mode initiates Live Sequential mode (displays channels in sequence).

18 ZOOM Button
Used to zoom in on a specific part of the screen. Once zoomed in, use the arrow buttons to pan around.















19 PTZ Button
Initiates PTZ mode and allows you to control the selected PTZ camera.

20 VIEW Button
Pressing the **VIEW** button while in PTZ mode displays the preset list.

21 SAVE Button
Press the **SAVE** button while in PTZ mode to save the current position as a preset.

22 MENU Button
Pressing the **MENU** button while in Live mode displays the Live menu. Alternatively, pressing the button while in Time-lapse Search mode displays the Control Area menu. Using the menu button in the control area, you can move the screen. **Top** by using this button in the **Control Area** menu displays the Search menu. For more information on the Control Area menu, refer to **Time-Lapse Search in the operation manual.**
Pressing and holding this button for 3 seconds activates One-Touch mode and displays the clip copy window while in Time-lapse Search mode. If the Search menu is displayed on the top of the screen, One-Touch mode is not activated.

23 Playback Buttons

	Scans backward through the video at a fast rate. (Press to cycle through  ,  , and )
	Plays the video in normal speed and displays  on the screen. Pressing the  button during playback pauses the video and displays  on the screen.
	Scans forward through the video at a fast rate. (Press to cycle through  ,  , and )
	Stops the video and restores Live mode.
	Skips to the previous screen (while in paused state).
	Skips to the next screen (while in paused state).

24 BOOKMARK Button
Adds a bookmark to the current playback position in search mode.

25 CLIP COPY Button
Used to perform Clip Copy.

26 MUTE Button
Temporarily disables audio.

Part 2 - Appendix

System Log Types

Boot Up	Panic On
System Shutdown	Panic Off
Restart	Clear All Data
Upgrade Success	Clear Disk
Upgrade Error	Format Disk
Power Failure	Disk Full
Time Changed	Auto Deletion
Time Zone Change	Search Begin
Time Sync.	Search End
Time Sync. Failed	Clip-Copy Begin
Disk Bad	Clip-Copy End
Login	Clip-Copy Cancel
Logout	Clip-Copy Failure
Setup Begin	Clip Copy User
Setup End	Clip-Copy Begin
Remote Setup Change	Clip-Copy Finished
Remote Setup Failure	Clip Copy Duration of Video
Setup Import	Clip Copy Camera
Setup Import Failure	Callback Failed
Setup Export	Factory Reset
Setup Export Failure	Camera Upgrade Begin
Setup Export Canceled	Camera Upgrade End
SNS Failure	Camera Upgrade Failure
Schedule On	Camera Upgrade User
Schedule Off	Camera Upgrade Camera





Error Code Types

Upgrade Error Codes			
No.	Type	No.	Type
0	Unknown Error	301	Remote Network Error
1	Incorrect File Version	302	No Remote Upgrade Permission
2	Incorrect OS Version	303	Remote Upgrade File Save Failure
3	Incorrect Software Version	304	Remote Upgrade Cancelled by User
4	Incorrect Kernel Version	400	USB Storage Device Mount Failure
100	Storage Device Mount Failure	401	USB Storage Device File Read Failure
101	File Not Found	402	USB Storage Device File Copy Failure
102	File Decompression Failure	403	USB Device Not Connected
103	LILO Execution Failure	404	USB Storage Device in Use
104	Reboot Failure	405	Unsupported File System
105	Improper File	500	Clip Copy in Progress: Upgrade Not Available
300	Remote Connection Failure		

Clip Copy Error Codes			
No.	Type	No.	Type
0	Unknown Error	12	Disk Error
1	Device Error	13	Clip Player Execution File Not Found
2	Device Connection Failure	14	Clip Player Execution File Access Failure
3	CD Media Not Found	15	Clip Player Execution File Save Failure
4	Incorrect Media	16	Image Generation Failure
5	File Name Taken	17	Burn Failure
6	Insufficient Space	18	Burn Time Overrun
7	Temporary File Generation Failure	19	Device Connection Failure
8	Disk Access Failure	20	Device in Use
9	Disk Format Failure	21	Unsupported File System
10	Database Changed	22	Data Validation Failure
11	Save Failure	23	No Saved Data within Range

Network Error Codes			
No.	Type	No.	Type
0	Cause of Failure Unknown	20	Connection Cancelled by User
1	Normal Logout	21	No Response from Network Device Host
2	All Channels in Use - Connection Denied	22	High Network Noise Level
3	Incorrect Product Version Info	23	Transmission Queue Full
4	Incorrect User Name or Password	24	Incorrect OEM Info
5	Forced Disconnection by Admin	25	No Search Permission
6	Timeout	26	Port in Use
7	Network Device Terminated	27	SSL Connection Failure
8	Unable to Connect: No Available Port	28	Network Timeout
9	Server Not in Operation: Unable to Connect	29	Network Device Host Timeout
11	Network Unavailable	30	RTP via TCP Not Supported by Network Device Host
12	Different Network Zone: Unable to Access	31	Socket Error
13	Connection Timeout	100	Unknown CODEC
14	Forced Disconnection by Network Device	101	.jpeg CODEC (not supported)
15	Network Device Host Terminated	103	.mpeg4 CODEC (not supported)
16	Unable to Route to Network Device Host	400	Unsupported Resolution
17	Connection Severed	-1	Normal Access

Troubleshooting

Problem	Solution
The main unit won't turn on.	<ul style="list-style-type: none"> • Check the power cable connection status. • Check the power outlet.
Unable to display Live video.	<ul style="list-style-type: none"> • Check the camera's video cable connection status. • Check the monitor's video cable connection status. • Check the camera's power setting. • Check the camera lens settings.
PoE-enabled camera will not turn on.	<ul style="list-style-type: none"> • Verify that the camera is actually PoE-enabled. • Check the network cable, replace it, and try again.
NVR stopped working in the middle of a recording.	<ul style="list-style-type: none"> • Hard disk may be full. Delete video recordings to free up space. • Set the NVR to Recycle mode. For more information, refer to the General in the operation manual.
 icon is shown, but video is not being recorded.	If the Pre-Event is enabled, the  and  icons appears when recording is not in progress, or the  and  icons appear when an event occurs and recording is in progress. For more information, refer to the Schedule in the operation manual .
The NVR keeps on rebooting during a system upgrade without completing the upgrade.	Check the upgrade file's version. To downgrade to a previous version, you must first press the factory reset button and reset all NVR settings to their factory defaults. A factory reset will clear all NVR settings configured by the user. For more information on factory reset, refer to the Factory Reset on page 16 .

Specifications

These product specifications may change without prior notice.

VIDEO	
Video Inputs	8/16/32 IP channels (DR-6308P-S, DR-6308P-SA/ DR-6316PS-S, DR-6316PS-S/ DR-6332PS-S, DR-6332PS-SA)
Video Outputs	1 HDMI, 1 VGA
Display Resolution	3840x2160, 1920 x 1200, 1920 x 1080, 1680 x 1050, 1600 x 1200
Display Speed	960ips @ Full HD (DR-6332PS-S/ DR-6332PS-SA) 480ips @ Full HD (DR-6316PS-S/ DR-6316PS-SA) 240ips @ Full HD (DR-6308P-S/ DR-6308P-SA)

* If more than 16 cameras from video encoders are registered on the NVR, video may not be displayed smoothly in a remote program.

* Recording speed may be slowed down during the RAID rebuild process.

RECORDING	
Max. Throughput	230Mbps, 960ips UHD (DR-6332PS-S/ DR-6332PS-SA) 180Mbps, 480ips@ UHD (DR-6316PS-S/ DR-6316PS-SA) 140Mbps, 240ips @ UHD (DR-6308P-S/ DR-6308P-SA)
Compression	H.264, H.265
Recording Mode	Time-Lapse, Event, Pre-Event, Panic

PLAYBACK	
Performance	16ch Full HD synchronous playback 4ch 4K playback (DR-6332PS-S/ DR-6332PS-SA)
	16ch Full HD synchronous playback 4ch 4K playback (DR-6316PS-S/ DR-6316PS-SA)
	8ch Full HD synchronous playback 4ch 4K playback (DR-6308P-S/ DR-6308P-SA)
Search Mode	Time-lapse, Event log, Thumbnail, Motion, Text-in

STORAGE	
HDD	SATA x6, eSATA x4,(Up to 8TB capacity for each disk), RAID 1 supported
Total Capacity	176TB=8TB x (6(Internal) + 4x4(External))
Data Export Device	USB HDD, USB Stick

NETWORK	
Client Connection	Gigabit Ethernet(Client) x1

Video in Connection	Gigabit Ethernet(IP Camera) x16 +Gigabit Ethernet(Ext) x1 (DR-6332PS-S/ DR-6332PS-SA) Gigabit Ethernet(IP Camera) x16 +Gigabit Ethernet(Ext) x1 (DR-6316PS-S/ DR-6316PS-SA) Gigabit Ethernet(IP Camera) x8 +Gigabit Ethernet(Ext) x1 (DR-6308P-S/ DR-6308P-SA)
Transmission Speed	50Mbps / 100Mbps(BRP Mode)
Camera Power	PoE(IEEE 802.3at class 4) supported 16 ports, 120W (DR-6332PS-S/ DR-6332PS-SA) PoE(IEEE 802.3at class 4) supported 16 ports, 120W (DR-6316PS-S/ DR-6316PS-SA) PoE(IEEE 802.3at class 4) supported 8 ports, 120W (DR-6308P-S/ DR-6308P-SA)
Event Notification	Email (attach clip (.cbf) .MP4), Callback to Remote S/W, Push notification (IDIS Mobile)

INTERFACE

Audio In / Out	Local(NVR) : 1 RCA / 1RCA + 1HDMI IP Camera : 32 / 32 (Depending on IP Camera) (DR-6332PS-S/ DR-6332PS-SA)
	Local(NVR) : 1 RCA / 1RCA + 1HDMI IP Camera : 16 / 16 (Depending on IP Camera) (DR-6316PS-S/ DR-6316PS-SA)
	Local(NVR) : 1 RCA / 1RCA + 1HDMI IP Camera :8 / 8 (Depending on IP Camera) (DR-6308P-S/ DR-6308P-SA)
NVR Alarm Spec- In	4 TTL, NC/NO programmable, 2.4V (NC) or 0.3V (NO) threshold, 5V DC
NVR Alarm Spec- Out	1 relay output, NC/NO, 2A@125V AC, 1A@30V DC
NVR Alarm Spec - Reset IN	1 TTL, terminal block
Internal Buzzer	Yes
Serial Interface	RS232 (Terminal Block), RS485 (Terminal Block)
USB	USB 2.0 x 1, USB 3.0 x 1

GENERAL

Operating System	Embedded Linux
Unit Dimensions (W x H x D)	430mm x 88mm x 412.8mm
Unit Weight	7.0kg(with 1HDD)
Working Temperature	0°C – 40°C (32°F ~ 104°F)
Operating Humidity	0% – 90%
Power	AC 100-240 V, 50/60Hz, 3.0 - 1.5A
Power Input	AC 100-240 V, 50/60Hz, 3.0 - 1.5A
Power Consumption	Max. 200W(with 6HDDs)
Approvals	FCC, UL, CE, CB



Some hard disks may not function properly when mounted on to this product. Refer to the compatibility chart below before mounting any additional hard disk on to the product. Hard disk compatibility chart is subject to change without notice. Contact your retailer for the latest compatibility chart.

Storage	Manufacturer	Model	Note
1TB	TOSHIBA	DT01ABA100V	
2TB	Western Digital	WD20PURX-64P6ZY0	
3TB	Western Digital	WD30PURX-64P6ZY0	
4TB	Western Digital	WD40PURX-64GVNT0	
8TB	Western Digital	WD80PUZX-64NEAY0	
10TB	Western Digital	HUH721010ALE600	
	SEAGATE	ST10000VX0004	DR-6308P-S/DR-6316PS-S/ DR-6308P-SA/DR-6316PS-SA



IDIS Co., Ltd.

For more information, please visit at
www.idisglobal.com